

## BF150 Flue Options

Use the table to select maximum vertical and horizontal flue routes. The number in the box is the restrictor plate size. X means it is not possible e.g. 9mts H with 11mts X. Burner width is 135cm, flue pipe required 130mm/200mm.

	0	1	2	3	4	5	6	7	8	9	10	11
0.5	X	X	X	X	X	X	X	X	X	X	X	X
1	50	50	50	30	30	30	0	0	0	X	X	X
2	70	50	50	30	30	0	0	0	0	0	0	X
3	70	50	30	30	30	30	0	0	0	0	0	0
4	70	50	30	30	30	30	0	0	0	0	0	0
5	70	50	30	30	30	30	0	0	0	0	0	0
6	50	30	30	30	30	30	0	0	0	0	0	X
7	50	30	30	30	30	30	0	0	0	0	X	X
8	50	30	30	30	30	30	0	0	0	X	X	X
9	50	30	30	30	30	30	0	0	X	X	X	X

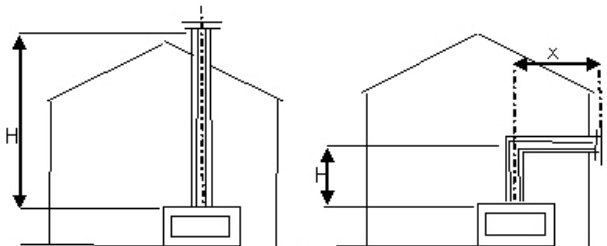
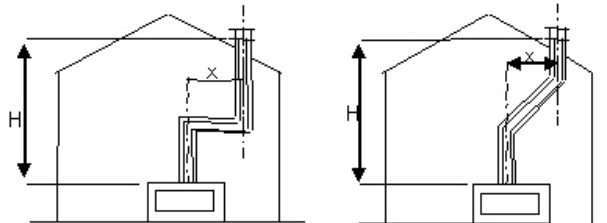

Burner 100cm, Flue 100/150mm  
All 110, 130 and 120 series

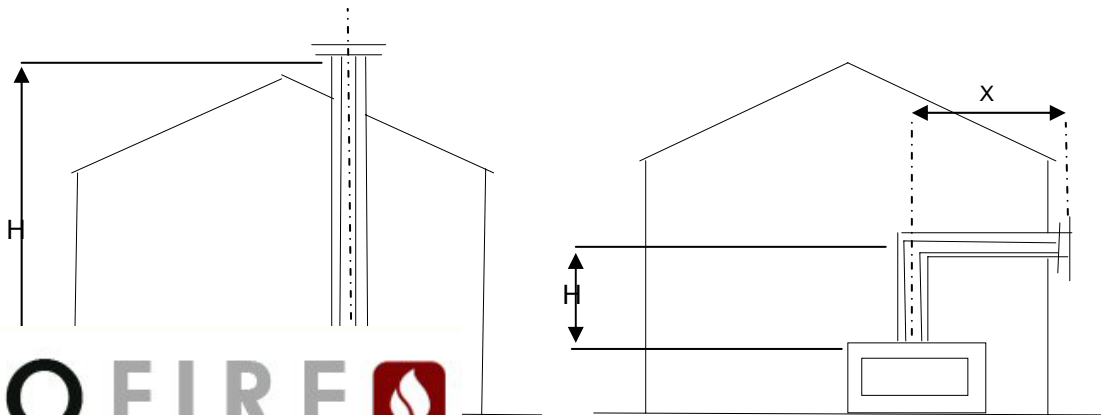
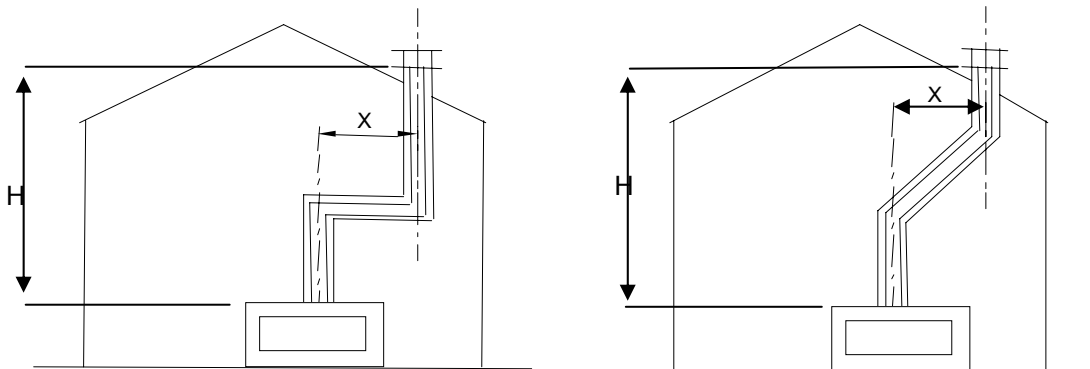

Burner 100cm, Flue 130/200mm  
All 110, 130 and 120 series

$\frac{X}{H}$	0	1	2	3	4	5	6	7	8	9	10	11
0.5	X	0	0	X	X	X	X	X	X	X	X	X
1	70	70	70	50	50	50	30	30	0	0	0	0
2	85	70	70	70	50	50	50	30	30	30	0	0

# CVO FIRE

3	85	85	70	70	70	50	50	50	30	30	0	0
4	85	85	70	70	70	50	50	50	30	30	0	0
5	85	85	70	70	70	50	50	50	30	30	0	0
6	70	85	70	70	70	50	50	50	30	30	0	0
7	70	85	70	70	70	50	50	50	30	30	0	0
8	70	85	70	70	70	50	50	50	30	30	0	0
9	70	85	70	70	70	50	50	50	30	30	0	0

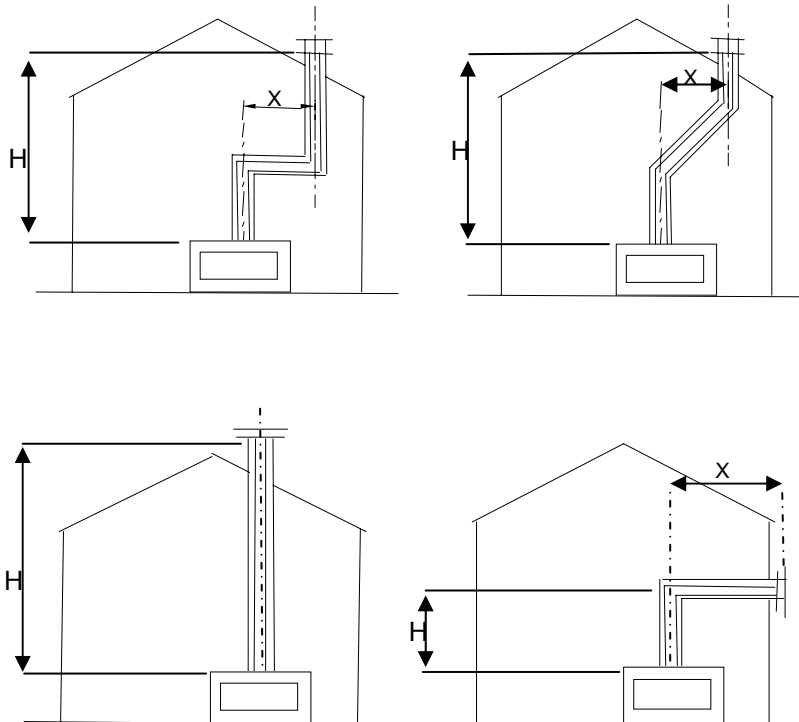

Burner 135cm, Flue 130/200 mm  
All 150 and 170 series

	0	1	2	3	4	5	6	7	8	9	10	11
0.5	X	X	X	X	X	X	X	X	X	X	X	X
1	50	50	50	30	30	30	0	0	0	X	X	X
2	70	50	50	30	30	0	0	0	0	0	0	X
3	70	50	30	30	30	30	0	0	0	0	0	0
4	70	50	30	30	30	30	0	0	0	0	0	0
5	70	50	30	30	30	30	0	0	0	0	0	0
6	50	30	30	30	30	30	0	0	0	0	0	X
7	50	30	30	30	30	30	0	0	0	0	X	X
8	50	30	30	30	30	30	0	0	0	X	X	X
9	50	30	30	30	30	30	0	0	X	X	X	X

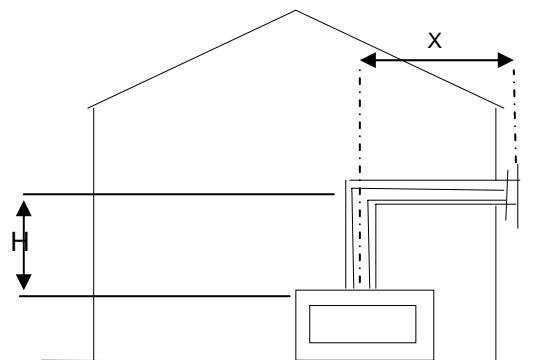
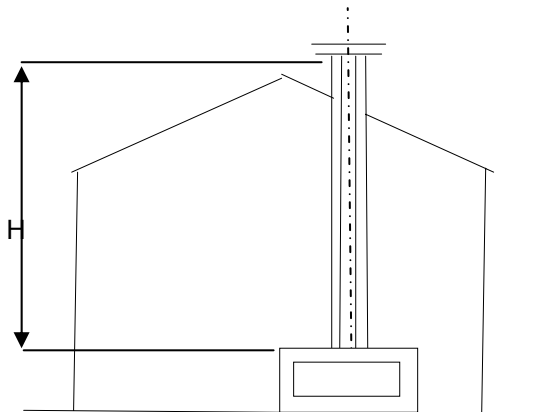
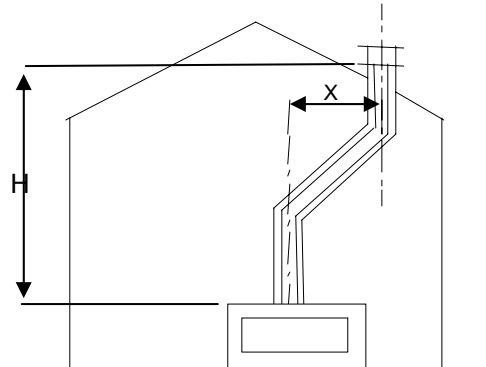
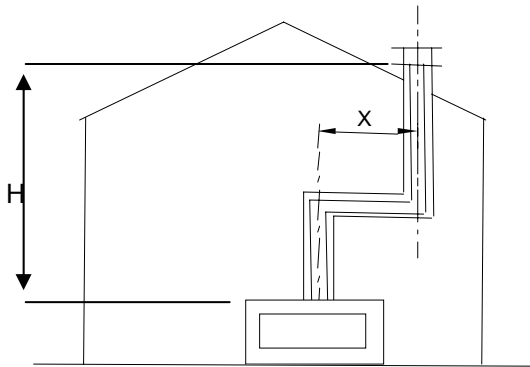

Burner 160cm, Flue 130/200 mm  
All 200 series

	0	1	2	3	4	5	6	7	8	9	10	11
0.5	X	X	X	X	X	X	X	X	X	X	X	X
1	50	30	30	0	0	0	X	X	X	X	X	X
2	50	50	30	30	0	0	0	X	X	X	X	X
3	50	50	30	30	30	0	0	0	X	X	X	X
4	50	50	30	30	30	0	0	0	X	X	X	X
5	50	50	30	30	30	0	0	0	X	X	X	X
6	50	50	30	30	30	0	0	0	X	X	X	X
7	50	50	30	30	30	0	0	0	X	X	X	X
8	50	50	30	30	30	0	0	0	X	X	X	X
9	50	50	30	30	30	0	0	0	X	X	X	X

